

# AN EFFICIENT APPROACH OF EXTERNAL COMMUNICATION SYSTEM IN AUTONOMOUS VEHICLES BASED ON CDMA

**KHATTAB M. ALI ALHEETI<sup>1</sup>, ABDULLAH MOHAMMED AWAD<sup>2</sup>, MUZHIR SHABAN AL-ANI<sup>3</sup>**

<sup>1</sup>College of Computer and Information Technology – Computer Networking Systems Dept., University of Anbar, Anbar -Iraq [co.khattab.alheeti@uoanbar.edu.iq]

Information System Department College of Computer, University of Anbar, Ramadi, Iraq  
am\_awad2@yahoo.com

University of Human Development, College of Science and Technology, Department of Information Technology, Sulaimani, KRG, Iraq [E-mail: muzhir.al-ani@uhd.edu.iq]

## ABSTRACT

There are large amounts of cars passing through the streets every day and this increases significantly in the morning or evening rush hours. The automotive industry has evolved greatly and many technologies have been introduced to automate many of its functions. The emergence of driverless vehicles has led to a boom in the world of automotive technology, because of its importance in creating a new environment and new concepts aimed at human conformability and increased productivity. Many solutions have been appeared to offer suitable self-driving vehicles environment that is capable to overcome the arising problems. When the self-driving vehicles are well equipped, the only remaining goal is how to control external communications with other vehicles, with updates that can appear in the road and with main center. This paper proposed code division multiple access as a communication technology to overcome the problems may appeared in time division multiple access. The synergy efforts in both industry and research centers giving powerful push to the intelligent transporting system. The proposed system of robot cars is implemented through high way environment scenario. The communication system is implemented via code division multiple access (CDMA) to realize high security, high quality of services, robustness and high capacity.

**Keywords:** V2V, Vehicular Networks, Self-Driving Vehicles, Multiple Access.

## 1. INTRODUCTION

The automotive industry has undergone a number of stages before reaching the form we know today [1,2]. The following is a review of the development stages of the automotive industry over time [3,4]. The steam engine was invented by the French inventor Nicolas Joseph Cuneo in 1769 [5,6]. Electric cars began to appear after the invention of Hungarian Anios Gedlik model of a small car powered by electricity in 1828 [7,8]. The actual application of cars powered by fuel engines began by Karl Benz in 1885 and was of a high standard compared to the cars that existed at the time [9,10]. The automobile industry flourished after the invention of fuel-powered engines, and manufacturers began buying engines from Benz

and Daimler to build modern cars [11,12]. The automakers began to flourish, and the first company was established in 1890 in France [13,14]. The modern cars that we use today have developed very significantly because of the great industrial development that has entered the car industry [15,16]. The technology and the smart systems have also entered the industry [17,18]. Modern cars have touch screens, voice commands, with a number of functions through the mobile phone, in addition to the modern cars to replace the key with the start button, and became the automotive systems rely on the electrical system helps in its work, and not rely entirely on fuel, and thus help to provide the fuel consumption will be significantly reduced [19,20].

Roads have always been owned and operated by governments, vehicles have been largely owned and maintained by individuals, and the use of road

space has not generally been based on a user payment model [21]. The future could challenge this model, since the vehicles can belong to a small number of important operators who charge their travel costs to their customers, thus taking advantage of a previously unassigned revenue stream [22].

The World's Road Safety Report 2015, which reflects information from 180 countries, indicated that the total number of deaths in road accidents has reached 1.25 million per year, and that the road mortality rates are the highest in low income developing countries [23]. Most of the accidents that lead to death are due to safety belts, drunk driving, high speed, motorcycle helmets and safety systems for children, this means that the main cause of accidents is human [24]. Therefore, resorting to the adoption of many technical methods to control these causes and reduce them as possible [25].

The cars have evolved and improved very rapidly and become a large part of their functions working automatically [26]. All these aimed to protect people inside and outside the car [27]. The ideas of the driver-less car appeared due to more than ten years ago and that the project Google 2009 was the first launch of those ideas [28]. Driverless cars try to change drivers by driving automation to decrease the number of accidents on the streets due to human error [29]. Autonomous vehicles use ad hoc networks, in vehicular ad hoc networks (VANET) [30]. These networks allow a more flexible and smart communication between vehicles in the radio coverage area [31].

The proposed system is a flexible communication system that is able to communicate between moving license vehicles and to main center considering any obstacle may appear in the environment. Communication system design based on CDMA technique to be more flexible and more secure comparing with TDMA. Basic structure of communication infrastructure in driverless cars is shown in figure 1.

The proposed external communication infrastructure of driverless cars aims to offer an efficient communications environment to work within the expected future Internet of Things (IoT).

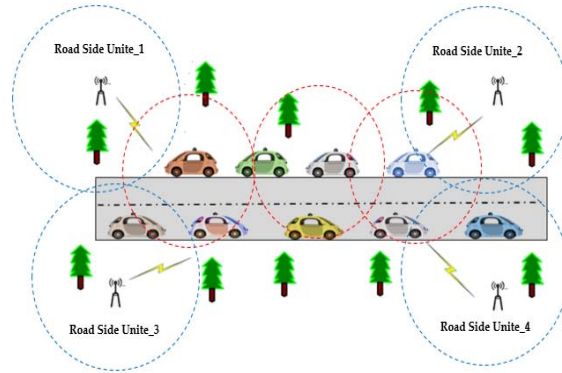

Figure 1 Shows Basic External Communication Infrastructure Of Driverless Cars.

We can easily notice that figure 1 contains from four road side unites (RSUs), driverless cars and semi-driverless cars. These RSUs play significant role in providing sufficient radio signal which help in exchange control data, information, cooperative awareness messages and notification messages.

The research is presented as follows: Section II provides at related works. Section III details about multiple access techniques that are utilised in exiting communication system. Section IV describes self-driving vehicle applications and its positive role on our society and section V explain methodology research. Section VII discusses outcomes of the proposed communication system whereas VIII concluded and a summary of future directions.

## 2. LITERATURE REVIEW

Autonomous vehicles are heavily based on their communication systems which are internal/ external system to sense surrounding environment to sense moving from point to others. In this case, researchers are considered communication system plays a vital role in developing and spreading self-driving vehicles. However, some projectors seek to improve current external communication system of self-driving cars. Moreover, performance of autonomous vehicles is enhanced by improving their external communication system as well as employing some new techniques such as, artificial intelligent. Some recent related works are explained in this paragraph.

Bassem Mokhtar et al. (2015) explained the diverse concerns of the VANET network and the protection constraints to obtain the obtainability of universal connectivity, protect infrastructures and

reputation organization schemes that affect trust in cooperation and negotiation between mobile network units. Then they analyse VANET protection aspects, challenges and attacks, and categorise VANET security intruders due to various layers of network [42].

Ribal F. Atallah et al. (2015) concentrated on the latest developments in each of the research areas mentioned above and highlights the open questions that remain unresolved in each one of them. Then the researchers were also involved in the design of programming policies to increase the efficiency of spectrum access and optimize the performance of vehicle networks based on several conventional metrics [43].

Raffaele Bruno et al. (2015) interested in the utilise of cars as components of a multimedia sensor structure capable of capturing snapshots of the camera on the roads to support traffic observing and urban surveillance tasks. They used sub-modular optimization methods to build robust and efficient information gathering systems for vehicle multimedia sensor networks. They explored an unconventional method to information collection that works on longer period measures and depend on solely on localized decisions instead of centralized calculations [44].

Hao Yang et al. (2016) analyzed analytically the immediate message capabilities of ad-hoc vehicular networks (VANET), that ration the upper limits of the communication broadcast rates of the vehicle. Subject to the interference between wireless broadcasts, the diffusion ability is defined by the extreme figure of successful receivers, and the capacity of unicast by the extreme figure of successful senders. With the procedure communication model and the constant traffic models, they establish closed formulas for capacities based on the broadcast sort, the interference ratio, the vehicle mass and the station size [45].

Jinho Lee et al. (2016) proposed a model of the expected link delay in a bidirectional route segment for reported data transmission schemes in vehicle networks. It is presented that the bidirectional link delay model is more accurate than the inherited bidirectional link delay model. Then, when employing this model to unicast control data, this model shown sufficiently precise to support the efficient unicast of information in VANETs [46].

Daxin Tian et al. (2016) proposed a model to analyze the collisions of the cars convey. It taken into account the effects of the dissimilar penetration

amounts, the stochastic nature of the inter-vehicular distance spreading and the various kinematic parameters related to the driver and the car. The ease of use and correctness of this system are verified through comparative experimentations with Monte Carlo simulations [47].

Susana Sousa (2017) presented a VANET agnostic architecture that allows the use of multiple communication technologies in an open and modular framework, which is an adaptation of the current standards approach, to be implemented in intelligent transport systems as a way to overcome its main limitations [48].

Tesnim Mekki et al. (2017) studied the model of the vehicular cloud in which focused on its characteristics and architectures. They present a description of the motivation of the vehicular cloud. Then they explored the challenges of the design. In addition, they highlighted the characteristics of cloud architectures of existing vehicles. They provided a taxonomy of vehicle clouds followed by classification criteria [49].

Gongjun Yan et al. (2017) analyzed the wireless connectivity between vehicles using mathematical models. They considered the consequence of distance, association time, acceleration, the comparative speed of cars, the range and size of messages / data in short-range car to car transportations. The numerical results in the simulations authenticate the analysis [50].

Khattab M. Ali Alheeti et al. (2018) proposed an intrusion identifying scheme to secure the communications system of autonomous vehicles. The security system is depended on clusters, using time division multiple access to expose some of the VANET barriers, such as high density, high mobility and bandwidth limitations in the exchange of messages. This changes the protection scheme to become more effective, precise and able to detect in real time and quickly identify the malicious behavior in the VANET [51].

Lucas Rivoirard et al. (2018) proposed a scheme of clustering that combines information about the configuration of the road, the mobility of the vehicle and the quality of the link, these three factors are used to design a structure similar to a VANETs, whereas it only depends on the vehicles. This method can be joined into any sensitive, active or geographical routing protocol to enhance flow of communications and abridge routing protocols [52].

Rajen Akalu (2018) explained the relationship between privacy, consent and personal information in relation to the car communications. Then

described ad hoc vehicle networks and the technical proposals to secure data. Then provided guidance on how a code of practice can help determine when individual consent will need to be improved and when alternatives to consent should be implemented [53].

Communication systems play an important issue in developing and implementing self-driving vehicles. Most of the related works are concentrated on improving internal and external communication systems of self-driving vehicles.

In our paper, a novel external communication system is proposed of autonomous vehicles that utilizes CDMA scheme to improve its communication performance. The significant contribution in this paper is enabled autonomous vehicles to exchange essential information and control data between vehicles and RSU in that radio converge area. Moreover, it enables vehicles can communicate event in waste communication case, such as: low bandwidth, accident and jamming.

### 3. SELF-DRIVING VEHICLES

Many car industries and companies expected that driverless vehicles will be ready on the road by 2020. Self-driving Vehicles will generate powerful benefits as shown in figure 2: [32,33,34,35,36].

#### 1) Reduce accidents

If committed to apply self-driving vehicle laws, so accidents have been reduced to the lowest possible. About 1.2 million people die every year from traffic accidents and about 94% of those accidents, are caused by human error.

#### 2) Increase driving

make driving possible again for people who could not drive such as disabled people or elderly people.

#### 3) Increase productivity

self-driving vehicle increase in human productivity that results from leave thinking about driving.

#### 4) Congestion avoidance

Congestion is a big problem experienced by many of the streets and the self-driving vehicle is equipped with techniques that enable them to choose the best ways to help ease congestion.

#### 5) Fuel saving

Electric self-driving vehicle is considered very economical because it needs only continuous

charging which does not cost.

#### 6) Reduce pollution

Since the electric self-driving vehicle relies on electric power, it does not cause any pollution compared to other cars.

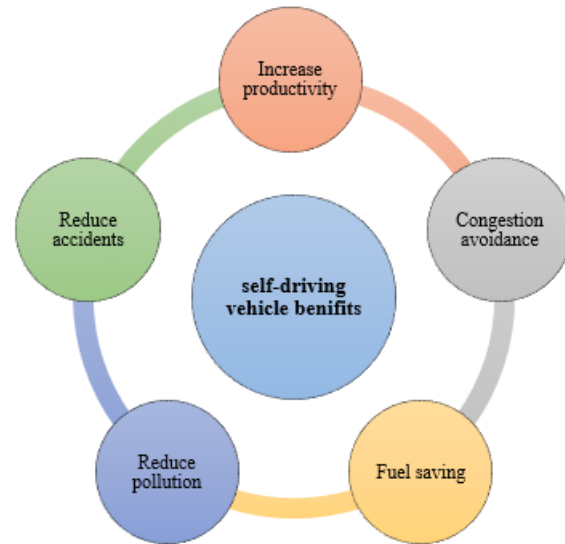

Figure 2 Powerful Benefits Of Self-Driving Vehicle.

The communication system of self-driving vehicles has characteristics that reason its characteristic performance obstacles: rapidity of the vehicle, fast change topology, lack of a fixed protection system, undefended medium communication and density of vehicles. All these obstacles made autonomous vehicles expose big challenges before explicitly on roads. However, we proposed new communication system which help driverless vehicles to overcome these obstacles. In more details, communication system of cars is heavily depended on efficient scheme that is code division multiple access (CDMA), more details in next section [37,38].

As we know, self-driving vehicles are modern fully automated vehicles that involve directly with carrying people, so it is very important to be safe with these vehicles. Thousands of people die every day because of traffic accident and most of these accidents are caused by humans. Recently, many expectations realise that self-driving vehicles will be ready on the road by 2020. Therefore, many motivations in this paper encourage us to find a new technique to improve communication system and overcome some transmission problems which throttle of autonomous vehicles.

#### 4. MULTIPLE ACCESS TECHNIQUES

Multiplexing is the procedure of joining numerous signals and transferring that in a public station. Then multiple access is the technique that utilised to permit multiple operators to interconnect over a single public network. There are many types multiple access techniques, that here will be reviewed some of these techniques such as frequency division multiple access (FDMA), time division multiple access (TDMA) and code division multiple access (CDMA) [37,38].

FDMA delivers amounts of frequency range to be used for information broadcast. The information is produced at base band and modulated at fluctuating radio regularities. Guard band is presented to escape intrusion. FDMA is used in first group analog communication schemes. FDMA is used to deliver each user with a duplex station [39].

TDMA permits multiple user to share a public frequency group by assigning diverse period times. Signals coming from each user will be transmitted at intervals depends on multiplying number channels into time slot. TDMA technology was used in second generation communication systems. Each operator is supported by eight TDMA in a 200 KHz bandwidth. Dynamic supply distribution predestined more operators could be sustenance 8 active operators at a period [40].

CDMA is a method in that information are modulated by great frequency orthogonal bits arrangement. These codes are used to propagation the signals above a huge band. The destination must have the similar dispersal bits sequence, that is increased by the merged signal in a manner named dispreading. In this case, CDMA is made very safe and forceful. The spreading code is designed to scramble the data signal. The spreading code changing much faster than data signal that meant much higher frequency that data signal.

CDMA was used in third generation communication systems [41]. CDMA is selected in design external communication system of autonomous vehicles for many reasons, such as:

- Speed: efficient consumption for bandwidth;
- Flexible: no need coordination and synchronization for establishing communication;
- Security: it considered an optimal solution for security problem i.e. protection against interference and tapping

[41].

#### 5. STATEMENT OF THE PROBLEM

The communication between autonomous vehicles becomes a big problem in the near future because of huge amount of driverless vehicles crossing roads in the modern cities. This research proposed an approach of external communications systems in autonomous vehicles based on CDMA.

#### 6. METHODOLOGY

External/internal communication systems are considered a backbone for any autonomous system without it cannot do anything. Moreover, all fundamental operations of autonomous vehicles are based on communication systems. Research methodology of novel communication system is explained in this subsection.

##### A. Code Division Multiple Access

Different radio communication methods are employed at CDMA. However, it enter within many access where some spreaders can broadcast data simultaneously over sole channel. This allowed several users to share band of frequencies to compete interference between users. CDMA implies spread spectrum technology and special coding scheme, where each transmitter is assigned to a unique code.

To explain the security of CDMA let us consider the transmitted data is distributed on the spreading code of eight bits in both slot\_0 and slot\_1, so it will be 16 bits as shown in Table 1. These two values are XORed to generate the output of the transmitter. Bit zero is represented by +1 and bit one is represented by -1. At the transmitter side of user1, the data bits to be transmitted is XORed with the spread code of slot\_0 and slot\_1 as shown in figure 3. At the receiver side, the received bits will be XORed with the same spread code to generate the received data that is exactly the same of the transmitted data as shown in Figure 4.

Table 1 CDMA Of Spreading Code For Bits.

	Slot_0 (transmitted)								Slot_1 (transmitted)							
Data bits	0	0	0	0	0	0	0	0	1	1	1	1	1	1	1	1
Data val.	+1	+1	+1	+1	+1	+1	+1	+1	-1	-1	-1	-1	-1	-1	-1	-1
Spread code	0	0	1	1	0	1	0	1	0	0	1	1	0	1	0	1
Code val.	+1	+1	-1	-1	+1	-1	+1	-1	+1	+1	-1	-1	+1	-1	+1	-1
X-OR bits	0	0	1	1	0	1	0	1	1	1	0	0	1	0	1	0
X-OR val.	+1	+1	-1	-1	+1	-1	+1	-1	-1	-1	+1	+1	-1	+1	-1	+1
	Slot_0 (received)								Slot_1 (received)							
Received bits	0	0	1	1	0	1	0	1	1	1	0	0	1	0	1	0
Received value	+1	+1	-1	-1	+1	-1	+1	-1	-1	-1	+1	+1	-1	+1	-1	+1
Spread code	0	0	1	1	0	1	0	1	0	0	1	1	0	1	0	1
Code val.	+1	+1	-1	-1	+1	-1	+1	-1	+1	+1	-1	-1	+1	-1	+1	-1
X-OR bits	0	0	0	0	0	0	0	0	1	1	1	1	1	1	1	1
X-OR val.	+1	+1	+1	+1	+1	+1	+1	+1	-1	-1	-1	-1	-1	-1	-1	-1

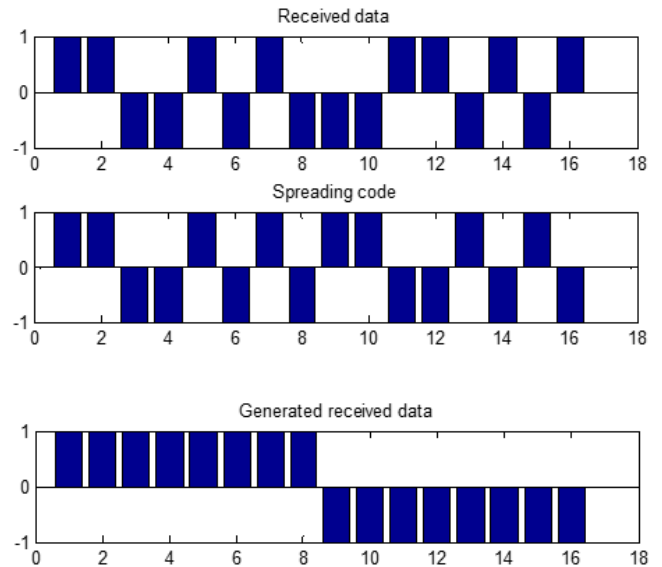

Figure 4 Receiver Side.

B. Transmitter / Receiver Structure

Considering 8 bits of spreading code, this leads to 256 separated users (vehicles) with unique code. All active users sending their spreading data into the channel. These data will be summed to form the composite signal that transmitted to all users through the channel as shown in figure 5. The sending data of the first channel (four bits) is spreaded into 32 bits according to the spreading code of 8 bits. The same thing is occurred for the other channels with their unique spreading code. All these spreading signals are summing to form the composite signal to be transmitted in the channel

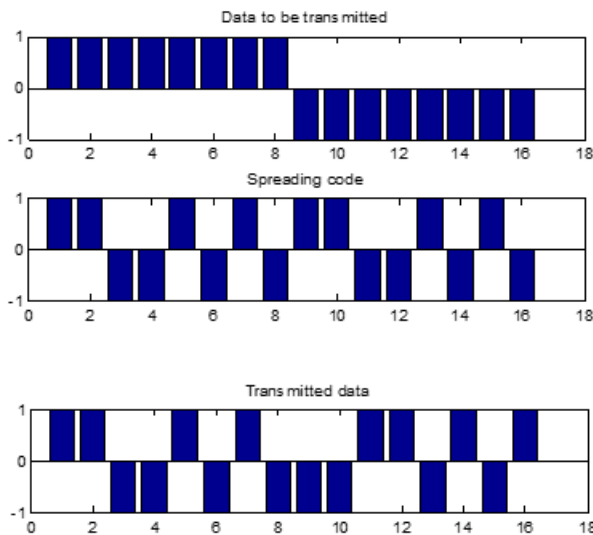

Figure 3 Transmitter Side.

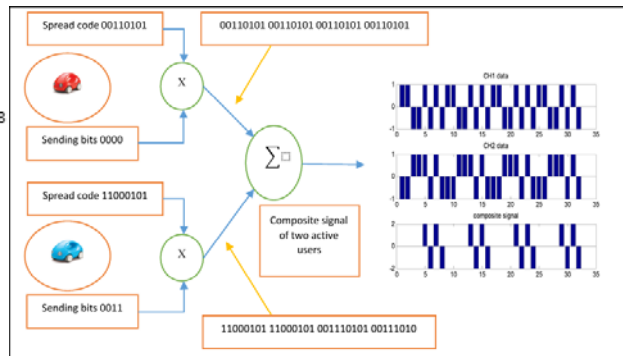

Figure 5 Cdma Transmitter.

On the other hand, the receiver structure is implemented to extract the original data signal of

each channel as shown in figure 6. The composite signal is received by the receiver, then this signal is spreading by the unique spread code of the indicated channel. After that the channel bits are extracted, then these values are compared. When the value is greater than zero, so it is represented by positive bit and when the value is less than zero, so it is represented by negative bit.

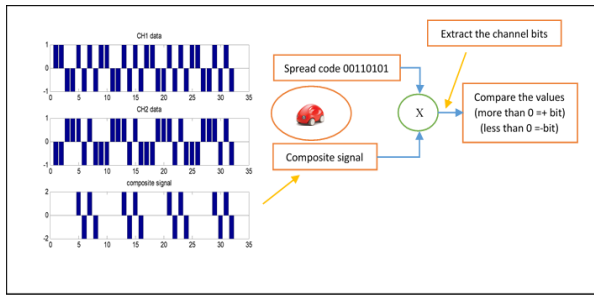

Figure 6 Cdma Receiver.

## 7. RESULTS AND DISCUSSIONS

In this subsection, CDMA and regular communication systems are tested of driverless and semi-driverless cars to test the suggested communication system performance. It was tested under various communication condition to confirm effective communication. One of the self-driving vehicles is programmed with the new CDMA communication system. The communication performance metrics are calculated of vehicles in two cases under same communication condition. Table 2 demonstrates the performance metrics which have been measured for same vehicle under CDMA communication system with and without the proposed communication scheme.

Table 2 Some Of Performance Metrics.

Performance Metrics	Vehicles without CDMA Communication System	Vehicles with CDMA Communication System
Transmission Packets	28800	28800
Received Packets	20128	26276
Packet Delivery Ratio	69.87%	91.22%
Totally Dropped Packets	9963	3508
Average End-to-End Delay	79.26ms	38.30ms

According to Table 2, the important part of the suggested communication scheme can be easily noticed distinguishing in two cases of autonomous vehicles. Calculated measured under malicious behaviour. The vital part of the suggested response method can be easily distinguishing in two circumstances of autonomous vehicles.

Conventional communication system need to be modified to adapt with new technology, such as self-driving vehicles. In other words, current security systems need to update to become more efficient with exiting communication systems. In addition, the proposed system plays important role in growing rate of packet that transmit between sender/ received as well as defensive these kids of VANETs.

The proposed CDMA communication system can enhance transmission rate of autonomous and semi-autonomous vehicles by increase packet delivery rate in its external communication communications. It is mainly for dropping any request that target broadcasting packets. Figure 7 shows the role of the CDMA communication in providing slot time for sent/ received packet between cars in that zone.

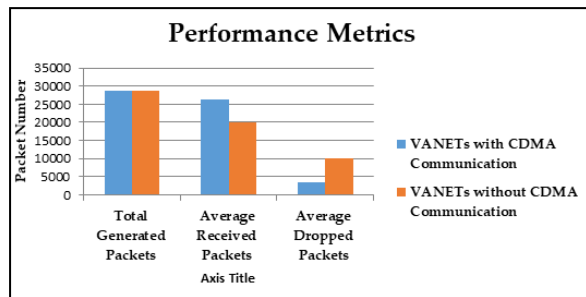

Figure 7 Performance Metrics For CDMA Communication System.

The figure 7 reflects a vital role of the CDMA system in improving the communication system of VANETs. It was evaluated under two various condition. The total number of generated packets is 28800 in two scenarios; the average number of received packets is 28800p in two situations; 26276p is number of packets that received at VANETs with CDMA system and average drop 3508p. However, 20128p is the number of packets that received at nodes and average drop packets is 9963p in VANETs with regular communication system. At this point, the researchers can identify a vital part of the suggested communication scheme in external communication of driverless cars.

This communication system is compared with a recent research paper [51] and conclude that the approach provides optimum communication performance for packets that received, packets delivery proportion, totally fell down packets and average time delay. The proposed scheme has a 91.22% packet delivery ratio, while the rival system does not provide an exact measure of the delivery

rate [51].

The employing new CDMA communication systems improve the delivery rate and reducing the amount of drop packets. Thus, CDMA system has direct and optimistic influence on the consequence by growing the delivery ration, and reducing the dropping packets, error rate and end-to-end delay ratio. The proposed communication system can be extended to design other communication system which can utilised artificial intelligent to select slot time intelligently.

## 8. CONCLUSION AND FUTURE WORK

The self-driving vehicles has leading to several advantages in the world of automotive technology, and creating a new environment and new concepts aimed at human road security, because of most of the road accidents are caused by human. The most important part of self-driving vehicles is how to introduce an efficient system to control all the required activities in this environment. Each vehicle has its unique identified code to be recognize from other vehicle and from the center. CDMA is introduced in this approach to generate a spreading code that is unique for each transmitter (vehicle). The spreading also code is used to extract the received data of the identify user. CDMA characterized the same frequency for high bandwidth, in addition of high security.

The recommendation of future work in self-driving vehicles environment is to adapt the overall system via the huge environment of Internet of Thing (IoT).

The most external communications systems in autonomous vehicles including this approach have main limitation due to large differences between existing systems.

## REFERENCES

- [1] J.J.M. Machado, P.M.-R. Gamarra, E.A.S. Marques, Lucas F.M. da Silva (2018) Improvement in impact strength of composite joints for the automotive industry, *Composites Part B: Engineering*, Volume 138, 1 April 2018, Pages 243-255.
- [2] Xavier Ferràs-Hernández, Elisenda Tarrats-Pons, Núria Arimany-Serrat (2017) Disruption in the automotive industry: A Cambrian moment, *Business Horizons*, Volume 60, Issue 6, November–December 2017, Pages 855-863.
- [3] J. Riznic (2017) CH1: Introduction to steam generators—from Heron of Alexandria to nuclear power plants: Brief history and literature survey, Book chapter, *Steam Generators for Nuclear Power Plants*, 2017, Pages 3-33.
- [4] Esa Kari Vakkilainen (2017) CH1: Principles of Steam Generation, Book chapter, *Steam Generation from Biomass*, 2017, Pages 1-17.
- [5] Karl Georg Høyer (2008) The history of alternative fuels in transportation: The case of electric and hybrid cars, *Utilities Policy*, Volume 16, Issue 2, June 2008, Pages 63-71.
- [6] Marc Dijk (2011) Technological frames of car engines, *Technology in Society*, Volume 33, Issues 1–2, February–May 2011, Pages 165-180.
- [7] Christoforos Mavrelou, Gerasimos Theotokatos (2018) Numerical investigation of a premixed combustion large marine two-stroke dual fuel engine for optimising engine settings via parametric runs, *Energy Conversion and Management*, Volume 160, 15 March 2018, Pages 48-59.
- [8] Yong Qian, Liang Yu, Zilong Li, Yahui Zhang, Xingcai Lu (2018) A new methodology for diesel surrogate fuel formulation: Bridging fuel fundamental properties and real engine combustion characteristics, *Energy*, Volume 148, 1 April 2018, Pages 424-447.
- [9] Taku Tsujimura, Yasumasa Suzuki (2017) The utilization of hydrogen in hydrogen/diesel dual fuel engine, *International Journal of Hydrogen Energy*, Volume 42, Issue 19, 11 May 2017, Pages 14019-14029.
- [10] Steven Gray (2017) Fueling mobility: coal and Britain's naval power, c. 1870–1914, *Journal of Historical Geography*, Volume 58, October 2017, Pages 92-103.
- [11] John Warner (2015) Chapter 2: History of Vehicle Electrification, Book chapter, *The Handbook of Lithium-Ion Battery Pack Design*, 2015, Pages 9-21.
- [12] Noriko Hikosaka Behling (2013) Chapter 3: History of Alkaline Fuel Cells, Book chapter, *Fuel Cells*, 2013, Pages 37-51.
- [13] Diya Thomas, Binsu C. Kooor (2018) A Genetic Algorithm Approach to Autonomous Smart Vehicle Parking system, *Procedia*



- Computer Science, Volume 125, 2018, Pages 68-76.
- [14] Barry Lambe, Niamh Murphy, Adrian Bauman (2017) Smarter Travel, car restriction and reticence: Understanding the process in Ireland's active travel towns, *Case Studies on Transport Policy*, Volume 5, Issue 2, June 2017, Pages 208-214.
- [15] José M. Cansino, Rocío Román, María J. Colinet (2018) Two smart energy management models for the Spanish electricity system, *Utilities Policy*, Volume 50, February 2018, Pages 60-72.
- [16] I. Zibani, R. Marumo, J. Chuma, I. Ngehani (2017) Software Controlled Stepping Valve System for a Modern Car Engine, *Procedia Manufacturing*, Volume 8, 2017, Pages 525-532
- [17] Aciek Ida Wuryandari, Yudi Satria Gondokaryono, I. Made Yoga Widnyana (2013) Design and Implementation of Driver Main Computer and Head up Display on Smart Car, *Procedia Technology*, Volume 11, 2013, Pages 1041-1047.
- [18] Chien-Hung Chen, Che-Rung Lee, Walter Chen-Hua Lu (2017) Smart in-car camera system using mobile cloud computing framework for deep learning, *Vehicular Communications*, Volume 10, October 2017, Pages 84-90.
- [19] Jihoon Hong, Jungwoo Shin, Daeho Lee (2016) Strategic management of next-generation connected life: Focusing on smart key and car-home connectivity, *Technological Forecasting and Social Change*, Volume 103, February 2016, Pages 11-20.
- [20] Liang Li, Xiangyu Wang, Jian Song (2017) Fuel consumption optimization for smart hybrid electric vehicle during a car-following process, *Mechanical Systems and Signal Processing*, Volume 87, Part B, 15 March 2017, Pages 17-29.
- [21] Md Whaiduzzaman, Mehdi Sookhak, Abdullah Gani, Rajkumar Buyya (2014) A survey on vehicular cloud computing, *Journal of Network and Computer Applications*, Volume 40, April 2014, Pages 325-344. <https://doi.org/10.1016/j.jnca.2013.08.004>.
- [22] Yousefi Saleh, Abbasi Tofigh, Anvari Zahra (2014) Transportation Routing in Urban Environments Using Updated Traffic Information Provided through Vehicular Communications, *Journal of Transportation Systems Engineering and Information Technology*, Volume 14, Issue 5, October 2014, Pages 23-36. [https://doi.org/10.1016/S1570-6672\(13\)60142-7](https://doi.org/10.1016/S1570-6672(13)60142-7).
- [23] Lien-Wu Chen, Yu-Chee Tseng, Kun-Ze Syue (2014) Surveillance on-the-road: Vehicular tracking and reporting by V2V communications, *Computer Networks*, Volume 67, 4 July 2014, Pages 154-163. <https://doi.org/10.1016/j.comnet.2014.03.031>.
- [24] João A.F.F. Dias, Joel J.P.C. Rodrigues, Liang Zhou (2014) Cooperation advances on vehicular communications: A survey, *Vehicular Communications*, Volume 1, Issue 1, January 2014, Pages 22-32. <https://doi.org/10.1016/j.vehcom.2013.11.003>.
- [25] Saif Al-Sultan, Moath M. Al-Doori, Ali H. Al-Bayatti, Hussien Zedan (2014) A comprehensive survey on vehicular Ad Hoc network, *Journal of Network and Computer Applications*, Volume 37, January 2014, Pages 380-392. <https://doi.org/10.1016/j.jnca.2013.02.036>.
- [26] Anand Paul, Naveen Chilamkurti, Alfred Daniel, Seungmin Rho (2017) Chapter 1: Introduction: intelligent vehicular communications, *Book chapter, Intelligent Vehicular Networks and Communications*, 2017, Pages 1-20. <https://doi.org/10.1016/B978-0-12-809266-8.00001-6>.
- [27] Jorge Alfonso, José E. Naranjo, José M. Menéndez, Arrate Alonso (2018) Chapter 3: Vehicular Communications, *Book chapter, Intelligent Vehicles*, 2018, Pages 103-139. <https://doi.org/10.1016/B978-0-12-812800-8.00003-5>.
- [28] Ryan Florin, Stephan Olariu (2015) A survey of vehicular communications for traffic signal optimization, *Vehicular Communications*, Volume 2, Issue 2, April 2015, Pages 70-79. <https://doi.org/10.1016/j.vehcom.2015.03.002>.
- [29] Omar Abdel Wahab, Hadi Otrok, Azzam Mourad (2013) VANET QoS-OLSR: QoS-based clustering protocol for Vehicular Ad hoc Networks, *Computer Communications*,

- Volume 36, Issue 13, 15 July 2013, Pages 1422-1435.  
<https://doi.org/10.1016/j.comcom.2013.07.003>.
- [30] Samira Harrabi, Walid Chainbi, Khaled Ghedira (2013) A Multi-agent Approach for Routing on Vehicular Ad-Hoc Networks, *Procedia Computer Science*, Volume 19, 2013, Pages 578-585.  
<https://doi.org/10.1016/j.procs.2013.06.077>.
- [31] Zohar Naor (2013) Fast and reliable handoff for vehicular networks, *Ad Hoc Networks*, Volume 11, Issue 7, September 2013, Pages 2136-2145.  
<https://doi.org/10.1016/j.adhoc.2012.05.002>.
- [32] Priyanka Rawat, Kamal Deep Singh, Jean Marie Bonnin (2016) Cognitive radio for M2M and Internet of Things: A survey, *Computer Communications*, Volume 94, 15 November 2016, Pages 1-29.  
<https://doi.org/10.1016/j.comcom.2016.07.012>.
- [33] Azzedine Boukerche, Robson E. De Grande (2018) Vehicular cloud computing: Architectures, applications, and mobility, *Computer Networks*, Volume 135, 22 April 2018, Pages 171-189.  
<https://doi.org/10.1016/j.comnet.2018.01.004>.
- [34] Ashwin Ashok, Peter Steenkiste, Fan Bai (2017) Vehicular Cloud Computing through Dynamic Computation Offloading, *Computer Communications*, In press, corrected proof, Available online 19 December 2017.  
<https://doi.org/10.1016/j.comcom.2017.12.011>.
- [35] Nasser Torabi, Behrouz Shahgholi Ghahfarokhi (2017) Survey of medium access control schemes for inter-vehicle communications, *Computers & Electrical Engineering*, Volume 64, November 2017, Pages 450-472.  
<https://doi.org/10.1016/j.compeleceng.2017.02.022>.
- [36] Omer Narmanlioglu, Bugra Turan, Sinem Coleri Ergen, Murat Uysal (2018) Cooperative MIMO-OFDM based inter-vehicular visible light communication using brake lights, *Computer Communications*, In press, corrected proof, Available online 13 February 2018.  
<https://doi.org/10.1016/j.comcom.2018.02.003>.
- [37] Ruchi Mittal, M.P.S. Bhatia (2018) Anomaly Detection in Multiplex Networks, *Procedia Computer Science*, Volume 125, 2018, Pages 609-616.
- [38] Lakshmi Anantharamu, Bogdan S. Chlebus (2015) Broadcasting in ad hoc multiple access channels, *Theoretical Computer Science*, Volume 584, 13 June 2015, Pages 155-176.
- [39] Michael Parker (2017) Chapter 17: Orthogonal Frequency Division Multiple Access Wireless Communications, Book chapter, *Digital Signal Processing 101 (Second Edition)*, 2017, Pages 209-230.  
<https://doi.org/10.1016/B978-0-12-811453-7.00017-2>.
- [40] Jun Suk Kim, Sungkil Lee, Min Young Chung (2018) Time-division random-access scheme based on coverage level for cellular internet-of-things in 3GPP networks, *Pervasive and Mobile Computing*, Volume 44, February 2018, Pages 45-57.  
<https://doi.org/10.1016/j.pmcj.2018.01.005>.
- [41] Mosa Ali Abu-Rgheff (2007) Chapter 6: Cellular Code Division Multiple Access (CDMA) Principles, Book chapter, *Introduction to CDMA Wireless Communications*, 2007, Pages 337-400.  
<https://doi.org/10.1016/B978-075065252-0.50007-7>.
- [42] Bassem Mokhtar, Mohamed Azab (2015) Survey on Security Issues in Vehicular Ad Hoc Networks, *Alexandria Engineering Journal*, Volume 54, Issue 4, December 2015, Pages 1115-1126.  
<https://doi.org/10.1016/j.aej.2015.07.011>.
- [43] Ribal F. Atallah, Maurice J. Khabbaz, Chadi M. Assi (2015) Vehicular networking: A survey on spectrum access technologies and persisting challenges, *Vehicular Communications*, Volume 2, Issue 3, July 2015, Pages 125-149.  
<https://doi.org/10.1016/j.vehcom.2015.03.005>.
- [44] Raffaele Bruno, Maddalena Nurchis (2015) Efficient data collection in multimedia vehicular sensing platforms, *Pervasive and Mobile Computing*, Volume 16, Part A, January 2015, Pages 78-95.  
<https://doi.org/10.1016/j.pmcj.2014.05.003>.
- [45] Hao Yang, Wen-Long Jin (2016) Instantaneous communication capacities of

- vehicular ad hoc networks, *Transportation Research Part C: Emerging Technologies*, Volume 72, November 2016, Pages 325-341. <https://doi.org/10.1016/j.trc.2016.10.005>.
- [46] Jinho Lee, Jaehoon (Paul) Jeong, David H.C. Du (2016) Two-way traffic link delay modeling in vehicular networks, *Computer Networks*, Volume 110, 9 December 2016, Pages 253-265. <https://doi.org/10.1016/j.comnet.2016.10.003>.
- [47] Daxin Tian, Jianshan Zhou, Yunpeng Wang, Zhengguo Sheng, Zhenguo Yi (2016) Modeling chain collisions in vehicular networks with variable penetration rates, *Transportation Research Part C: Emerging Technologies*, Volume 69, August 2016, Pages 36-59. <https://doi.org/10.1016/j.trc.2016.05.013>.
- [48] Susana Sousa, Alexandre Santos, António Costa, Bruno Dias, Óscar Gama (2017) A New Approach on Communications Architectures for Intelligent Transportation Systems, *Procedia Computer Science*, Volume 110, 2017, Pages 320-327. <https://doi.org/10.1016/j.procs.2017.06.101>.
- [49] Tesnim Mekki, Issam Jabri, Abderrezak Rachedi, Maher ben Jemaa (2017) Vehicular cloud networks: Challenges, architectures, and future directions, *Vehicular Communications*, Volume 9, July 2017, Pages 268-280. <https://doi.org/10.1016/j.vehcom.2016.11.009>
- [50] Gongjun Yan, Danda B. Rawat (2017) Vehicle-to-vehicle connectivity analysis for vehicular ad-hoc networks, *Ad Hoc Networks*, Volume 58, April 2017, Pages 25-35. <https://doi.org/10.1016/j.adhoc.2016.11.017>.
- [51] Khattab M. Ali Alheeti, Muzhir Shaban Al-Ani, Klaus McDonald-Maier (2018) A hierarchical detection method in external communication for self-driving vehicles based on TDMA”, *PLoS ONE* 13(1): e0188760, January 9, 2018. <https://doi.org/10.1371/journal.pone.0188760>.
- [52] Lucas Rivoirard, Martine Wahl, Patrick Sondi, Marion Berbineau, Dominique Gruyer (2018) Chain-Branch-Leaf: A clustering scheme for vehicular networks using only V2V communications, *Ad Hoc Networks*, Volume 68, January 2018, Pages 70-84. <https://doi.org/10.1016/j.adhoc.2017.10.007>.
- [53] Rajen Akalu (2018) Privacy, consent and vehicular ad hoc networks (VANETs), *Computer Law & Security Review*, Volume 34, Issue 1, February 2018, Pages 37-46. <https://doi.org/10.1016/j.clsr.2017.06.006>.