

See discussions, stats, and author profiles for this publication at: <https://www.researchgate.net/publication/380291383>

Metaheuristic Optimization of Maximum Power Point Tracking in PV Array under Partial Shading

Article in *Engineering, Technology and Applied Science Research* · June 2024

DOI: 10.48084/etasr.7385

CITATIONS

3

READS

166

3 authors:



Mohammed Qasim Taha

University of Anbar

58 PUBLICATIONS 411 CITATIONS

[SEE PROFILE](#)



Mohammed kareem Mohammed

University of Anbar

8 PUBLICATIONS 38 CITATIONS

[SEE PROFILE](#)



Bamba Heiba

University of Nouakchott Al Aasriya

10 PUBLICATIONS 39 CITATIONS

[SEE PROFILE](#)

Metaheuristic Optimization of Maximum Power Point Tracking in PV Array under Partial Shading

Mohammed Qasim Taha

Department of Biophysics, College of Applied Sciences-Hit, University of Anbar, Iraq
mohammed.taha@uoanbar.edu.iq (corresponding author)

Mohammed Kareem Mohammed

Renewable Energy Research Center, University of Anbar, Iraq
mohammed.kareem@uoanbar.edu.iq

Bamba El Heiba

Applied Research Unity to Renewable Energies (URA3E), University of Nouakchott, Mauritania
bmb.ahmed.heiba@gmail.com

Received: 29 March 2024 | Revised: 13 April 2024 | Accepted: 15 April 2024

Licensed under a CC-BY 4.0 license | Copyright (c) by the authors | DOI: <https://doi.org/10.48084/etasr.7385>

ABSTRACT

Optimal energy harvesting is dependent on the efficient extraction of energy from photovoltaic (PV) arrays. Maximum Power Point Tracking (MPPT) algorithms are crucial in achieving the maximum power harvest from the PV systems. Therefore, in response to a fluctuating power generation rate due to shading of the PV, the MPPT algorithms must dynamically adapt to the PV array's Maximum Power Point (MPP). In this article, three metaheuristic optimization MPPT techniques, utilized in DC converters connected to the array of 4 PV panels, are compared. The Particle Swarm Optimization (PSO), Genetic Algorithm (GA), and Ant Colony Optimization (ACO), which are used to optimize MPPT in the converter, are compared. This research evaluates the efficiency of each optimization method in converging to MPP under 2 s after partial shading of the PV with respect to velocity and accuracy. All algorithms exhibit fast MPPT optimization. However, among the evaluated algorithms, the PSO was distinguished for its higher stability and efficiency.

Keywords-MPPT optimization; photovoltaics; metaheuristics; convergence evaluation; partial shading

I. INTRODUCTION

Photovoltaic (PV) systems have emerged as a promising renewable energy source (RES), providing electric energy in a sustainable manner. Nevertheless, the dynamic and nonlinear properties of PV systems present serious obstacles to effective energy harvesting, hence efficient Maximum Power Point Tracking (MPPT) methods are essential [1-4]. Nowadays, optimization algorithms have become increasingly well-known due to their capacity to search complex solution spaces. The integration of more PV and RESs into the electric grid has gained considerable importance in mitigating environmental issues and meeting energy demands [5, 6]. PV arrays are composed of individual panels connected in a way that reduces the negative effects of shading, dust, and local heat on panel performance. Thus, MPPT algorithms are crucial to continually attaining MPP, as they dynamically adapt the operational point of the PV array to follow the dynamic changes in MPP caused by environmental effects [7-9].

Metaheuristic optimization algorithms have attracted attention for resolving complex search space problems [10]. These optimization methodologies draw inspiration from natural and social behaviors and present a strategy to deliver resilient and effective solutions across a wide range of application domains. Metaheuristic optimization algorithms, such as Particle Swarm Optimization (PSO) [11], Genetic Algorithm (GA) [12], and Ant Colony Optimization (ACO) [13] have been investigated as potential substitutes for conventional approaches in MPPT for PV arrays under partial shading. Optimization techniques have been the subject of many studies in an attempt to improve energy harvesting efficiency. Authors in [14] studied the efficiency of the PSO-based MPPT algorithms in a grid-connected PV system. The results indicated that the PSO-based algorithms outperformed the conventional Perturb and Observe (P&O) algorithms in terms of tracking accuracy. In addition, a hybrid GA-PSO algorithm for MPPT, which demonstrated enhanced convergence speed and stability when operating in dynamic

generation, was introduced in [15]. Conventional approaches, including P&O and Incremental (INC) algorithms, are simple in structure and computational implementation [16]. However, they have several disadvantages, entailing a slow convergence rate, fluctuations near the MPP, and susceptibility to failure due to sudden changes in irradiance from shading or temperature [17]. In order to address these limitations, researchers have followed optimization methods to provide resilient solutions for complex optimization problems [18]. Thus, there has been considerable interest in algorithms, such as PSO, GA, and ACO, to enhance the performance of MPPT systems. PSO-based MPPT algorithms are useful in improving the monitoring accuracy and stability of grid-connected PV systems and their efficiency has been demonstrated in several studies [19-24]. Similarly, the authors in [25-28] have utilized GA to optimize MPPT during dynamic operating conditions. GA demonstrates enhanced convergence speed and robustness compared to conventional techniques. Furthermore, ACO optimization based MPPT has been investigated for standalone PV systems in [29] and [30], with encouraging results of adaptability to generation variation.

In this work, three optimization MPPT methods are studied through the implementation of PSO, GA, and ACO algorithms. Although several investigations have provided optimization methods for MPPT, a comparative analysis of their performance under partial shading lacks. Thus, the objective of this paper is to fill this research gap through a detailed comparison of the MPPT's performance with respect to the convergence speed and accuracy of three MPPT optimization methods during partial shading of the PV array. This research contributes to the field of MPPT algorithms and can help in the integration of more PV energy into the energy grid.

II. METHODOLOGY

A. Metaheuristic Optimization Algorithms

PSO is a type of population-based optimization algorithm inspired by the social behavior of bird flocks and fish in their swarm motion. In PSO, a swarm of particles iteratively adjusts their positions as they scan the search space to locate the optimal solution. Every particle symbolizes a resolution and modifies its location. The best-known location worldwide is determined by the swarm as a whole [31]. Two factors govern particle motion: social influence and inertia. Inertia controls the momentum of the particle, enabling it to sustain its trajectory, whereas social influence guides the particle towards the most widely recognized position on a global space. Therefore, in a case of partial shading of the PV array, the PSO iteratively modifies the MPPT behavior via the generation of switching pulses that control the converter switch to find the MPP.

The GA is an algorithm deployed for evolutionary optimization and is inspired by genetics and the process of natural selection. Over generations, a population of candidate solutions represented as chromosomes evolves towards more optimal solutions through selection and mutation processes. One chromosome is responsible for obtaining the solution of optimization parameters. The fitness assessment of MPPT optimization objectives is the highest PPT of the PV array. GA optimization iteratively finds the solution when the objective

function is satisfied [32]. ACO is an algorithm for probabilistic optimization, inspired by the metallurgical process of annealing, which attempts to identify the global optimum. ACO emulates the cooling process of molten metal to take random solutions and increase the fitness of the solutions as the search continues. ACO perturbs the solution at each iteration by executing a stochastic movement within the search space. The revised solution depends on the temperature parameter and the extent of degradation. ACO reduces the temperature according to a predetermined schedule until a minimum temperature is reached. Finally, it assesses the solution based on the objective function value. For an MPPT problem, ACO investigates the solution space of the DC converter to identify the best gate switching to meet the specified constraints while finding the MPP of the PV array [33]. In Table I, the complexity, convergence time, and performance tradeoffs for each algorithm are illustrated.

TABLE I. COMPARISON OF THE STUDIED ALGORITHMS

Algorithm	Complexity	Convergence time	Trade-offs
PSO	Moderate	Fast	Faster convergence in high-dimensional spaces
GA	Moderate to High	Moderate	Global exploration but longer convergence time, needs more computational resources
ACO	Moderate to High	Variable	Robust to local optima, but potentially longer convergence time. Suitable for complex problem spaces.

B. Model Simulation

The PV array used in this investigation consists of four solar panels connected in series, as noticed in Figure 1. Each panel exhibits different current-voltage (I-V) and power-voltage (P-V) properties. The characteristic I-V and P-V curves of the panel (Tata TP250MBZ) employed in this simulation are depicted in Figure 2.

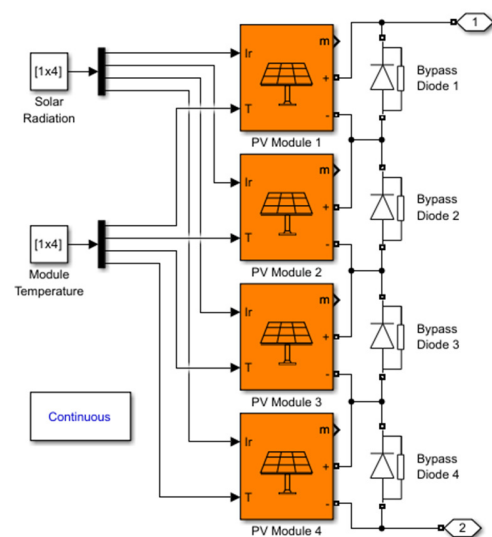

Fig. 1. The PV array with partial shading and 25 °C temperature operation.

These curves demonstrate the nonlinear correlation between the output power and voltage as the irradiance level and temperature vary. The array was subjected to partial shading of 50%, 20%, and 0%. The specifications of the PV panels are detailed in Table II. The panels engaged in this experimental simulation are based on the Tata TP250MBZ PV, which is widely used in PV systems [34].

TABLE II. THE SPECIFICATION OF TATA TP250MBZ MODULE

Specification	Value
Maximum power (W)	250
Cells per module	60
Open circuit voltage V_{OC} (V)	36.8
Short-circuit current I_{SC} (A)	8.8
Voltage at maximum power point V_{MP} (V)	30
Current at maximum power point I_{MP} (A)	8.3

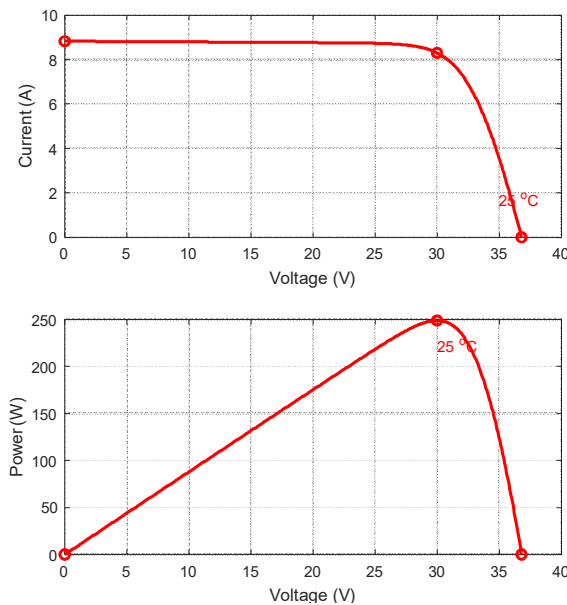

Fig. 2. The characteristic I-V and P-V curves produced from a Tata TP250MBZ panel (1 series module; 1 parallel strings).

The Matlab/Simulink environment was utilized to simulate the PV array model. The PV array was integrated with an optimized DC converter to maximize energy harvesting capability under partial shading. The simulation setup is portrayed in Figure 3. The former includes a DC converter switching control with the aim of controlling its output voltage and current according to the best MPP and thus facilitating DC energy flow from the PV array to the batteries or inverter [35]. PSO, GA, and ACO optimization algorithms have been employed to optimize the DC converter for attaining MPPT under a shaded PV array. The evaluated factors to produce fast and accurate MPPT, include response time, stability, and efficiency [36]. The integration of the shaded PV array with the optimized DC converter was conducted to evaluate the efficiency of the optimization algorithms to find MPP during the variable energy generation from the system caused by partial shading.

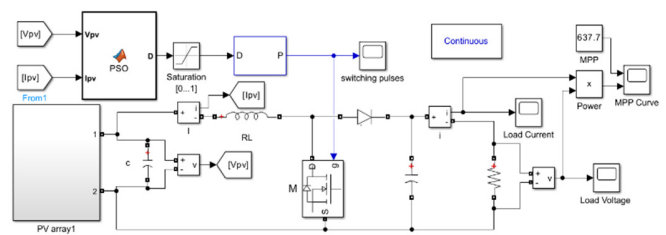

Fig. 3. The schematic of a DC converter with MPPT optimization.

III. RESULTS AND DISCUSSION

The switching pulses produced by the DC converter optimized for MPPT applying the PSO algorithm are illustrated in Figure 4. The switching pulses of the DC converter are the initial drive for the effective regulation of the converter. The converter current waveform associated with PSO optimization is displayed in Figure 5. The load voltage profile acquired using PSO-based MPPT is illustrated in Figure 6.

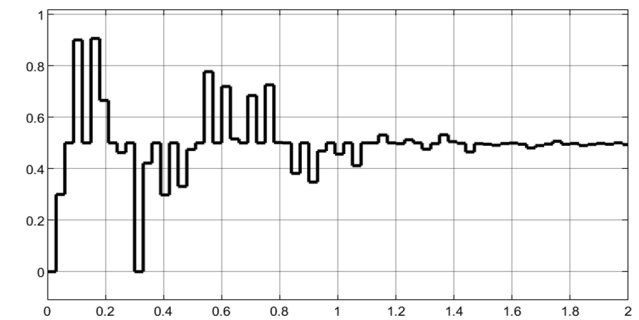

Fig. 4. Switching pulses of the optimized MPPT using the PSO algorithm.

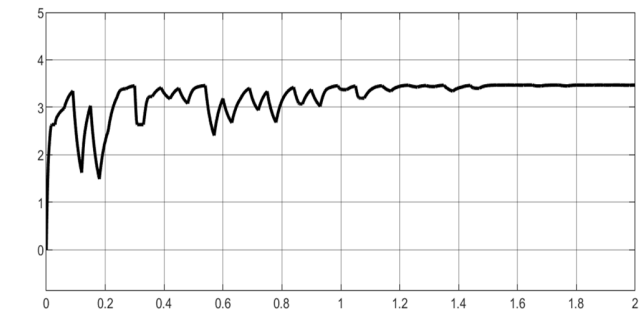

Fig. 5. MPPT current for DC converter optimized MPPT using PSO.

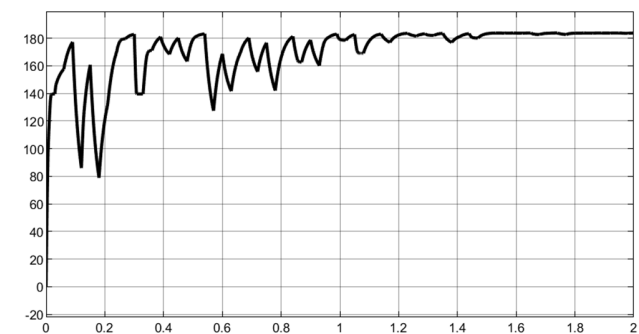

Fig. 6. MPPT voltage for DC converter optimized MPPT using PSO.

By maintaining a stable voltage and closely monitoring the intended operating point, reliable power supply to the load is ensured. The current demonstrates negligible variations and closely corresponds to the intended reference value, suggesting that power regulation is functioning efficiently. The power output of the PV array as obtained through the PSO-based MPPT is depicted in Figure 7. The system shows rapid convergence toward MPP after $t = 1.2$ s and maintains a consistent power output.

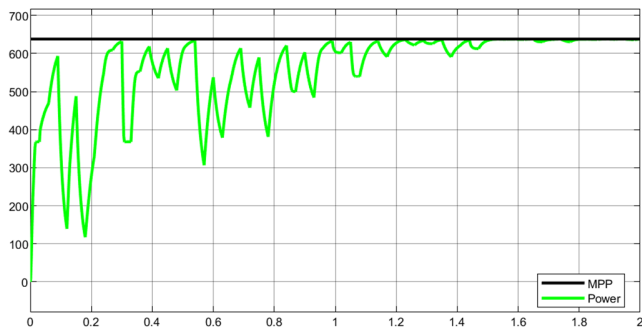

Fig. 7. The convergence towards MPP for DC converter based on optimized MPPT using PSO.

The switching pulses produced by the DC converter that was optimized with the GA algorithm for MPPT are presented in Figure 8. The output current waveform of the GA optimization based MPPT is demonstrated in Figure 9. The current discloses small fluctuations compared to the reference value.

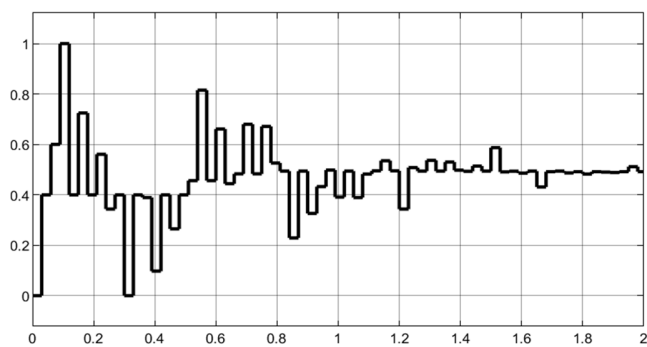

Fig. 8. Switching pulses of the optimized MPPT using GA algorithm.

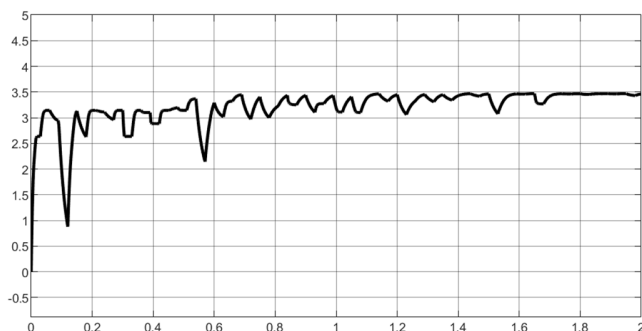

Fig. 9. MPPT current for DC converter optimized MPPT using GA.

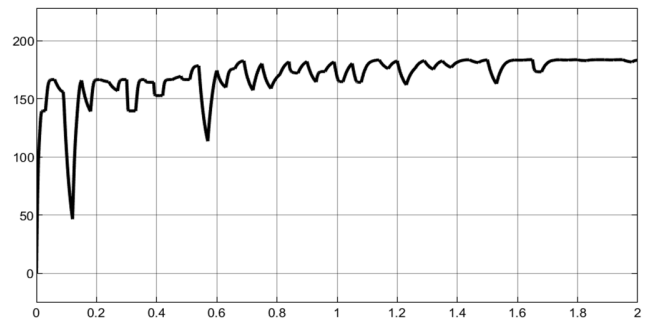

Fig. 10. MPPT voltage for DC converter optimized MPPT using GA.

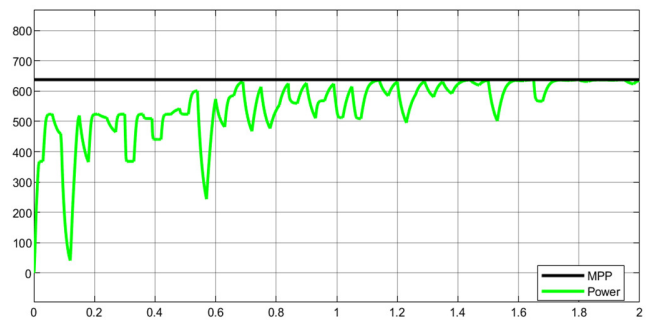

Fig. 11. The convergence towards MPP for DC converter based on optimized MPPT using GA.

Figure 10 illustrates the profile of the output voltage of the converter acquired through the GA-based MPPT. Similarly to the PSO optimization, the voltage closely follows the intended operating point to ensure stable power delivery. The power output of the PV array optimized using the GA-based MPPT is depicted in Figure 11. Similarly to PSO, the DC converter quickly converges to MPP after $t = 1.7$ s and maintains a stable power output. The switching pulses produced by the DC converter optimized with ACO for MPPT are shown in Figure 12. The transition rates of the pulses are marginally lower in comparison to the PSO and GA optimizations. The load current waveform associated with the ACO optimization is displayed in Figure 13. Although the current closely approximates the reference value, it may demonstrate marginally greater variability than PSO and GA. Figure 14 portrays the load voltage profile acquired through the ACO-based MPPT. Even though the voltage remains constant at the intended operating point, it demonstrates marginally greater fluctuations compared to PSO and GA. In Figure 15, the power output of the PV array is determined by the ACO-based MPPT. The DC converter converges to MPP at 1.1 s and although it finds the MPP early, it exhibits less accuracy and efficiency than PSO and GA optimizations. ACO is surpassed in terms of MPPT speed and accuracy by PSO and GA. Both PSO and GA demonstrate quick convergence to MPP and maintain a stable MPPT with negligible fluctuations around the maximum power of the panel. Although ACO exhibits good MPPT performance, its convergence speed is marginally slower than that of PSO and GA. Therefore, the PSO and GA outperform ACO when applied to PV systems that showcase dynamic characteristics and require rapid and accurate MPPT due to partial shading of the panels or other natural reasons.

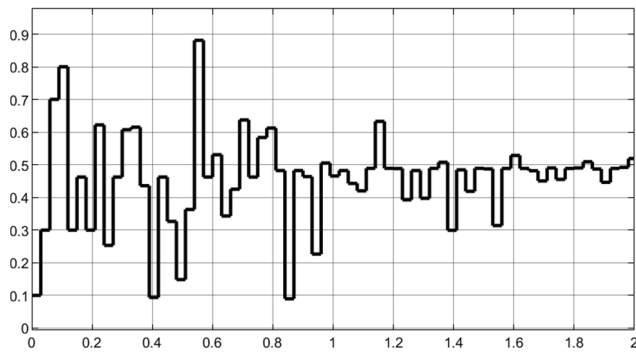

Fig. 12. Switching pulses of optimized MPPT using ACO.

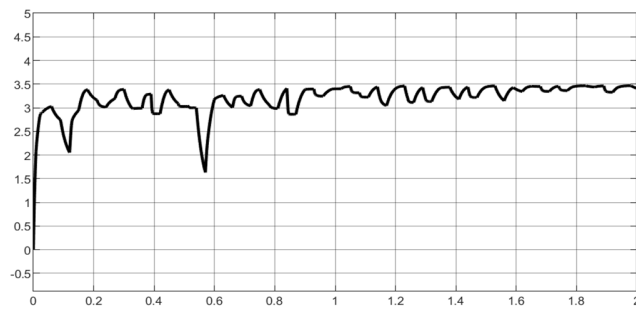

Fig. 13. MPPT current for DC converter optimized MPPT using ACO.

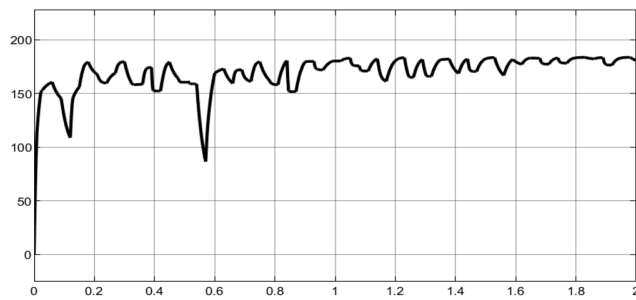

Fig. 14. MPPT voltage for DC converter optimized MPPT using ACO.

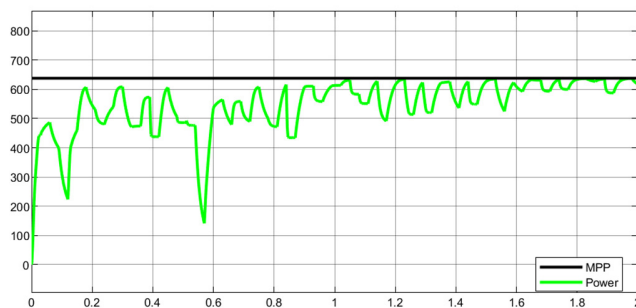

Fig. 15. The convergence towards MPP for DC converter based on optimized MPPT using ACO.

TABLE III. MPPT PERFORMANCE OF EACH ALGORITHM

Algorithm	Convergence time (s)	Stability	Efficiency
PSO	1.2	High	High
GA	1.7	Moderate	Moderate
ACO	1.1	Poor	Poor

PSO exhibited the best performance among the algorithms tested. GA presented similar performance, but with lower convergence speed and more MPP fluctuation. Table III reveals the performance comparison of the studied algorithms. Overall, the ACO, PSO, and GA algorithms for MPPT demonstrate excellent performance. Nevertheless, the comparison between these algorithms indicates that PSO outperforms others in terms of stability and efficiency.

IV. CONCLUSIONS

In this study, Particle Swarm Optimization (PSO), Genetic Algorithm (GA), and Ant Colony Optimization (ACO) algorithms for Maximum Power Point Tracking (MPPT) in Photovoltaic (PV) systems under partial shading fluctuation have been investigated. The efficient tracking of MPP in PV arrays is a complex problem due to the nonlinear and dynamic characteristics of the panels. Thus, MPPT speed and accuracy of each optimization algorithm are evaluated to assess the robustness and efficiency of the algorithm. The convergence speed to MPP and the maintenance of a constant power output with minimal fluctuations were studied. Although ACO demonstrated high speed convergence, it is not stable, and its efficiency is poor. PSO and GA have been identified as better options for MPPT under shading effects because of their faster and accurate response. The PSO algorithm was identified as the best algorithm for MPPT in terms of stability and efficiency for PV arrays under dynamic shading. Sustainable energy generation from PV can be fully exploited by advancing MPPT algorithms to increase the efficient integration of PVs and other renewable energy sources (RESs) into the energy networks. Further improvements in the effectiveness and resilience of MPPT algorithms can be achieved by utilizing machine learning methods, such as neural networks, reinforcement learning, and evolutionary algorithms to create hybrid optimization strategies and so improve the performance of PV systems under various conditions.

REFERENCES

- [1] J. Maeng, J. Jeong, I. Park, M. Shim, and C. Kim, "A Time-Based Direct MPPT Technique for Low-Power Photovoltaic Energy Harvesting," *IEEE Transactions on Industrial Electronics*, vol. 71, no. 5, pp. 5375–5380, May 2024, <https://doi.org/10.1109/TIE.2023.3288183>.
- [2] S. Hota, M. K. Sahu, and J. M. R. Malla, "A Standalone PV System with a Hybrid P&O MPPT Optimization Technique," *Engineering, Technology & Applied Science Research*, vol. 7, no. 6, pp. 2109–2112, Dec. 2017, <https://doi.org/10.48084/etasr.1374>.
- [3] M. Q. Taha, "Advantages and recent advances of smart energy grid," *Bulletin of Electrical Engineering and Informatics*, vol. 9, no. 5, pp. 1739–1746, Oct. 2020, <https://doi.org/10.11591/eei.v9i5.2358>.
- [4] O. Abdel-Rahim and H. Wang, "A new high gain DC-DC converter with model-predictive-control based MPPT technique for photovoltaic systems," *CPSS Transactions on Power Electronics and Applications*, vol. 5, no. 2, pp. 191–200, Jun. 2020, <https://doi.org/10.24295/CPSSPEA.2020.00016>.
- [5] B. Heiba, A. M. Yahya, M. Q. Taha, N. Khezam, and A. K. Mahmoud, "Performance analysis of 30 MW wind power plant in an operation mode in Nouakchott, Mauritania," *International Journal of Power Electronics and Drive Systems (IJPEDS)*, vol. 12, no. 1, pp. 532–541, Mar. 2021, <https://doi.org/10.11591/ijped.v12.i1.pp532-541>.
- [6] B. Korich, A. Benaissa, B. Rabhi, and D. Bakria, "A Novel MPPT Design for a Partially Shaded PV System Using Spotted Hyena Optimization Algorithm," *Engineering, Technology & Applied Science*

- Research, vol. 11, no. 6, pp. 7776–7781, Dec. 2021, <https://doi.org/10.48084/etasr.4490>.
- [7] S. Xu, R. Shao, B. Cao, and L. Chang, "Single-phase grid-connected PV system with golden section search-based MPPT algorithm," *Chinese Journal of Electrical Engineering*, vol. 7, no. 4, pp. 25–36, Dec. 2021, <https://doi.org/10.23919/CJEE.2021.000035>.
- [8] M. Q. Taha and M. A. Lpizra, "Design a new PWM switching technique in multilevel converters," in *2016 Annual Connecticut Conference on Industrial Electronics, Technology & Automation (CT-IETA)*, Oct. 2016, pp. 1–4, <https://doi.org/10.1109/CT-IETA.2016.7868257>.
- [9] X. Li, H. Wen, Y. Hu, Y. Du, and Y. Yang, "A Comparative Study on Photovoltaic MPPT Algorithms Under EN50530 Dynamic Test Procedure," *IEEE Transactions on Power Electronics*, vol. 36, no. 4, pp. 4153–4168, Apr. 2021, <https://doi.org/10.1109/TPEL.2020.3024211>.
- [10] M. Y. Allani, D. Mezghani, F. Tadeo, and A. Mami, "FPGA Implementation of a Robust MPPT of a Photovoltaic System Using a Fuzzy Logic Controller Based on Incremental and Conductance Algorithm," *Engineering, Technology & Applied Science Research*, vol. 9, no. 4, pp. 4322–4328, Aug. 2019, <https://doi.org/10.48084/etasr.2771>.
- [11] M. K. Mohammed, M. Q. Taha, F. F. Salih, and F. N. Saeed, "Optimization and fault diagnosis of 132 kV substation low-voltage system using electrical transient analyzer program," *International Journal of Electrical and Computer Engineering (IJECE)*, vol. 13, no. 3, pp. 2375–2383, Jun. 2023, <https://doi.org/10.11591/ijece.v13i3.pp2375-2383>.
- [12] M. Etezadinejad, B. Asaei, S. Farhangi, and A. Anvari-Moghaddam, "An Improved and Fast MPPT Algorithm for PV Systems Under Partially Shaded Conditions," *IEEE Transactions on Sustainable Energy*, vol. 13, no. 2, pp. 732–742, Apr. 2022, <https://doi.org/10.1109/TSTE.2021.3130827>.
- [13] M. Q. Taha and S. Kurnaz, "Droop Control Optimization for Improved Power Sharing in AC Islanded Microgrids Based on Centripetal Force Gravity Search Algorithm," *Energies*, vol. 16, no. 24, Jan. 2023, Art. no. 7953, <https://doi.org/10.3390/en16247953>.
- [14] L. Liu, C. Huang, J. Mu, J. Cheng, and Z. Zhu, "A P&O MPPT With a Novel Analog Power-Detector for WSNs Applications," *IEEE Transactions on Circuits and Systems II: Express Briefs*, vol. 67, no. 10, pp. 1680–1684, Oct. 2020, <https://doi.org/10.1109/TCSII.2019.2940212>.
- [15] A. T. Saeed, M. Q. Taha, and A. K. Ahmed, "Tracking technique for the sudden change of PV inverter load," *International Journal of Power Electronics and Drive Systems (IJPEDS)*, vol. 10, no. 4, pp. 2076–2083, Dec. 2019, <https://doi.org/10.11591/ijpeds.v10.i4.pp2076-2083>.
- [16] M. J. Alshareef, "An Effective Falcon Optimization Algorithm Based MPPT Under Partial Shaded Photovoltaic Systems," *IEEE Access*, vol. 10, pp. 131345–131360, 2022, <https://doi.org/10.1109/ACCESS.2022.3226654>.
- [17] M. S. Zidan, M. Q. Taha, L. A. Yaseen, N. D. Hameed, and Q. N. Abid, "Measurement and assessment of mobile network electromagnetic radiation pollution in Ramadi, Iraq," *Bulletin of Electrical Engineering and Informatics*, vol. 11, no. 5, pp. 2679–2686, Oct. 2022, <https://doi.org/10.11591/eei.v11i5.3938>.
- [18] K. Y. Yap, C. R. Sarimuthu, and J. M.-Y. Lim, "Artificial Intelligence Based MPPT Techniques for Solar Power System: A review," *Journal of Modern Power Systems and Clean Energy*, vol. 8, no. 6, pp. 1043–1059, Nov. 2020, <https://doi.org/10.35833/MPCE.2020.000159>.
- [19] M. Q. Taha, M. H. AL-Jumali, and A. K. Ahmed, "Modeling the Dielectric Mediums Impact on Coaxial Transmission Line Performance," *Journal of Engineering and Applied Sciences*, vol. 13, no. 20, pp. 8419–8425, Jun. 2018, <https://doi.org/10.36478/jeasci.2018.8419.8425>.
- [20] J. Dadkhah and M. Niroomand, "Optimization Methods of MPPT Parameters for PV Systems: Review, Classification, and Comparison," *Journal of Modern Power Systems and Clean Energy*, vol. 9, no. 2, pp. 225–236, Mar. 2021, <https://doi.org/10.35833/MPCE.2019.000379>.
- [21] Y. S. Alwan, M. S. Zidan, and M. Q. Taha, "Evaluation of mobile microwave radiation severity at al-door residential complex in Iraq," *Indonesian Journal of Electrical Engineering and Computer Science*, vol. 14, no. 3, pp. 1281–1285, Jun. 2019, <https://doi.org/10.11591/ijeecs.v14.i3.pp1281-1285>.
- [22] H. Bassi and Y. A. Mobarak, "State-Space Modeling and Performance Analysis of Variable-Speed Wind Turbine Based on a Model Predictive Control Approach," *Engineering, Technology & Applied Science Research*, vol. 7, no. 2, pp. 1436–1443, Apr. 2017, <https://doi.org/10.48084/etasr.1015>.
- [23] I. C. Elhassene *et al.*, "Early degradation factors of solar 33 kV grid connected power plant, a comparative study," *International Journal of Power Electronics and Drive Systems (IJPEDS)*, vol. 15, no. 1, pp. 442–453, Mar. 2024, <https://doi.org/10.11591/ijpeds.v15.i1.pp442-453>.
- [24] I. Rahul and R. Hariharan, "Enhancement of Solar PV Panel Efficiency Using Double Integral Sliding Mode MPPT Control," *Tsinghua Science and Technology*, vol. 29, no. 1, pp. 271–283, Feb. 2024, <https://doi.org/10.26599/TST.2023.9010030>.
- [25] O. J. Ibrahim, M. Zidan, B. R. Al-Doori, M. Q. Taha, and N. E. Islam, "A Microstrip on Planar Antenna Designs for Cognitive Radio Applications," *International Journal on Communications Antenna and Propagation (IRECAP)*, vol. 13, no. 2, pp. 98–107, Apr. 2023, <https://doi.org/10.15866/irecap.v13i2.22277>.
- [26] A. Ostadrahimi and Y. Mahmoud, "Novel Spline-MPPT Technique for Photovoltaic Systems Under Uniform Irradiance and Partial Shading Conditions," *IEEE Transactions on Sustainable Energy*, vol. 12, no. 1, pp. 524–532, Jan. 2021, <https://doi.org/10.1109/TSTE.2020.3009054>.
- [27] M. S. Zidan *et al.*, "A New Approach for the Design of Frequency Reconfigurable Antenna for Cognitive Radio Applications," *International Review of Electrical Engineering (IREE)*, vol. 18, no. 4, pp. 310–319, Aug. 2023, <https://doi.org/10.15866/iree.v18i4.22280>.
- [28] L. Shang, H. Guo, and W. Zhu, "An improved MPPT control strategy based on incremental conductance algorithm," *Protection and Control of Modern Power Systems*, vol. 5, no. 1, Dec. 2020, Art. no. 14, <https://doi.org/10.1186/s41601-020-00161-z>.
- [29] A. Ahmed, M. Taha, and A. S. Mustafa, "On-road Automobile License Plate Recognition Using Co-Occurrence Matrix," *Journal of Advanced Research in Dynamical and Control Systems*, vol. 10, no. 7, pp. 387–393, Jun. 2018.
- [30] P. Kumar, R. K. Singh, and R. Mahanty, "Performance of MPPT-Based Minimum Phase Bipolar Converter for Photovoltaic Systems," *IEEE Transactions on Power Electronics*, vol. 36, no. 5, pp. 5594–5609, May 2021, <https://doi.org/10.1109/TPEL.2020.3030690>.
- [31] M. Zidan, L. A. Yaseen, O. J. Ibrahim, M. Q. Taha, S. A. Rashid, and N. E. Islam, "Development and Analysis of Miniaturized Antennas for a Cognitive Radio System in Interweave Mode," *International Journal on Communications Antenna and Propagation (IRECAP)*, vol. 13, no. 1, pp. 10–21, Feb. 2023, <https://doi.org/10.15866/irecap.v13i1.21892>.
- [32] Z. Zhao, F. Luo, J. Zhu, and G. Ranzi, "Multi-Stage Mobile BESS Operational Framework to Residential Customers in Planned Outages," *IEEE Transactions on Smart Grid*, vol. 14, no. 5, pp. 3640–3653, Sep. 2023, <https://doi.org/10.1109/TSG.2023.3245094>.
- [33] M. Q. Taha, Z. H. Ali, and A. K. Ahmed, "Two-level scheduling scheme for integrated 4G-WLAN network," *International Journal of Electrical and Computer Engineering (IJECE)*, vol. 10, no. 3, pp. 2633–2643, Jun. 2020, <https://doi.org/10.11591/ijece.v10i3.pp2633-2643>.
- [34] J. M. Riquelme-Dominguez and S. Martinez, "Systematic Evaluation of Photovoltaic MPPT Algorithms Using State-Space Models Under Different Dynamic Test Procedures," *IEEE Access*, vol. 10, pp. 45772–45783, 2022, <https://doi.org/10.1109/ACCESS.2022.3170714>.
- [35] M. H. Al-Jumaili, A. S. Abdalkafor, and M. Q. Taha, "Analysis of the hard and soft shading impact on photovoltaic module performance using solar module tester," *International Journal of Power Electronics and Drive Systems (IJPEDS)*, vol. 10, no. 2, pp. 1014–1021, Jun. 2019, <https://doi.org/10.11591/ijpeds.v10.i2.pp1014-1021>.
- [36] B. Guo *et al.*, "Optimization Design and Control of Single-Stage Single-Phase PV Inverters for MPPT Improvement," *IEEE Transactions on Power Electronics*, vol. 35, no. 12, pp. 13000–13016, Dec. 2020, <https://doi.org/10.1109/TPEL.2020.2990923>.